

# ProStar™

## Solar Charging System Controller

### Installation, Operation, and Maintenance Manual



[www.morningstarcorp.com](http://www.morningstarcorp.com)



#### MODELS

---

PS-15

PS-30

PS-15M

PS-30M

## DIMENSIONS [inches (millimeters)]

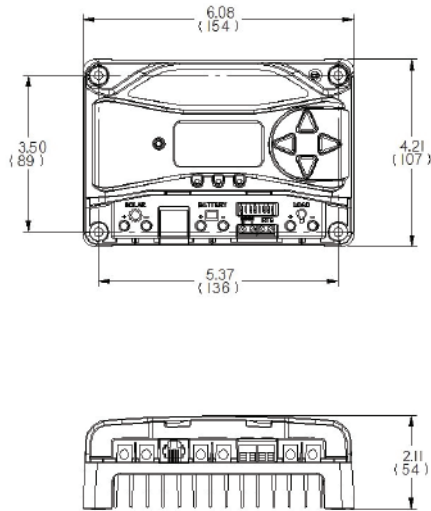

SPECIFICATION SUMMARY		
	PS-15 / PS-15M	PS-30 / PS-30M
Nominal Battery voltage	12 or 24V	12 or 24V
Max. PV Open- Circuit Voltage*	30 or 60V	30 or 60V
Max. Battery Charging Current	15A	30A
Rated Load Current	15A	30A

\*Array voltage should never exceed this limit

## TABLE OF CONTENTS

<b>1.0 Important Safety Instructions.....</b>	<b>1</b>
<b>2.0 General Information.....</b>	<b>13</b>
2.1 Overview.....	13
2.2 Regulatory Information.....	14
2.3 Features.....	16
2.4 Optional Accessories.....	18
<b>3.0 Installation.....</b>	<b>21</b>
3.1 General Installation Notes.....	21
3.2 Configuration.....	23
3.3 Mounting.....	26
3.4 Wiring.....	27
3.4.1 Wire Sizing.....	27
3.4.2 Required Overcurrent Protection Devices (OCPDs) and Disconnects.....	30
3.4.3 Wiring Connections.....	35
<b>4.0 Operation.....</b>	<b>47</b>
4.1 Battery Charging Information.....	47
4.2 Load Control Information.....	60
4.3 LED Indications.....	62
4.3.1 Power-up.....	62
4.3.2 Status LED.....	62
4.3.3 State-of-charge LEDs.....	63
4.4 Push-button Use in Non-Metered Versions.....	64
4.5 Custom Settings.....	65
4.5.1 Programming with Meter Display.....	65

(Cont.)

## TABLE OF CONTENTS (Cont.)

4.5.2	Programming in MSView.....	67
4.5.3	Meter Display Operation.....	67
4.5.3.1	Directional Key Use and Operation / Navigating the Meter Map.....	67
4.5.3.2	Adjusting the Meter Display.....	68
4.5.4	Using the Meter Display to Program Charging Set-points, Load Control, Communications, and Advanced Settings.....	68
4.5.5	Lighting Control - Programming Overview.....	68
4.5.6	Lighting Programming Using Meter Display....	69
4.5.7	Low-Temperature Foldback.....	70
4.6	Inspection and Maintenance.....	71
<b>5.0</b>	<b>Troubleshooting.....</b>	<b>73</b>
5.1	Alarms.....	73
5.2	LED Fault Indications.....	74
5.3	Battery Charging and Performance Issues.....	79
<b>6.0</b>	<b>Warranty and Policies.....</b>	<b>81</b>
<b>7.0</b>	<b>Technical Specifications.....</b>	<b>84</b>
<b>Appendix A - De-rating.....</b>		<b>88</b>
<b>Appendix B - Wire Sizing.....</b>		<b>88</b>

## CERTIFICATION ADDENDUM TO OPERATOR'S MANUAL

## 1.0 IMPORTANT SAFETY INSTRUCTIONS

### SAVE THESE INSTRUCTIONS.

This manual contains important safety, installation, operating and maintenance instructions for the ProStar solar controller.

The following symbols are used throughout this manual to indicate potentially dangerous conditions or mark important safety instructions:



**WARNING:** Indicates a potentially dangerous condition. Use extreme caution when performing this task.



**CAUTION:** Indicates a critical procedure for safe and proper operation of the controller.



**NOTE:** Indicates a procedure or function that is important to the safe and proper operation of the controller.

### CONSIGNES IMPORTANTES DE SÉCURITÉ CONSERVEZ CES INSTRUCTIONS:

Ce manuel contient des instructions importantes de sécurité, d'installations et d'utilisation du contrôleur solaire ProStar.

Les symboles suivants sont utilisés dans ce manuel pour indiquer des conditions potentiellement dangereuses ou

des consignes importantes de sécurité.



**AVERTISSEMENT :** Indique une condition potentiellement dangereuse. Faites preuve d'une prudence extrême lors de la réalisation de cette tâche.



**PRUDENCE :** Indique une procédure critique pour l'utilisation sûre et correcte du contrôleur.



**REMARQUE :** Indique une procédure ou fonction importante pour l'utilisation sûre et correcte du contrôleur.

## Safety Information

- Read all of the instructions and cautions in the manual before beginning installation.
- There are no user serviceable parts inside the ProStar. Do not disassemble or attempt to repair the controller.



**WARNING: Risk Of Electrical Shock.** NO POWER OR ACCESSORY TERMINALS ARE ELECTRICALLY ISOLATED FROM DC INPUT, AND MAY BE ENERGIZED WITH HAZARDOUS SOLAR VOLTAGE. UNDER CERTAIN FAULT CONDITIONS, BATTERY COULD BECOME OVER-CHARGED. TEST BETWEEN ALL TERMINALS AND GROUND BEFORE TOUCHING.



**WARNING: THE COMMUNICATIONS PORT IS CONSIDERED TO BE DVC B. AN EXTERNAL ISOLATOR IS REQUIRED IF IT IS TO BE CONNECTED TO A DVC A CIRCUIT.**

- External solar and battery disconnects are required.
- Disconnect all sources of power to the controller before installing or adjusting the ProStar.
- There are no fuses or disconnects inside the ProStar. Do not attempt to repair.

## Informations de Sécurité

- Lisez toutes les instructions et les avertissements figurant dans le manuel avant de commencer l'installation.
- Le ProStar ne contient aucune pièce réparable par l'utilisateur. Ne démontez pas ni ne tentez de réparer le contrôleur.



**AVERTISSEMENT: Risque De Choc Électrique.** NON ALIMENTATION OU AUX BORNES D'ACCESSOIRES SONT ISOLÉS ÉLECTRIQUEMENT DE L'ENTRÉE DE C.C ET DOIT ÊTRE ALIMENTÉS À UNE TENSION DANGEREUSE SOLAIRE. SOUS CERTAINES CONDITIONS DE DÉFAILLANCE, LA BATTERIE POURRAIT DEVENIR TROP CHARGÉE. TEST ENTRE TOUTES LES BORNES ET LA MASSE AVANT DE TOUCHER.



**AVERTISSEMENT: LE PORT DE COMMUNICATION EST CONSIDÉRÉE COMME DVC B. UN ISOLATEUR EXTERNE N'EST NÉCESSAIRE SI C'EST D'ÊTRE CONNECTÉ À**

### UN DVC UN CIRCUIT.

- External solaire et la batterie se déconnecte sont nécessaires.
- Déconnectez toutes les sources d'alimentation du contrôleur avant d'installer ou de régler le ProStar.
- Le ProStar ne contient aucun fusible ou interrupteur. Ne tentez pas de réparer.
- Installez des fusibles/coupe-circuits externes selon le besoin.

### Installation Safety Precautions



**WARNING:** *This unit is not provided with a GFDI device. This charge controller must be used with an external GFDI device as required by the Article 690 of the National Electrical Code for the installation location.*

- Mount the ProStar indoors. Prevent exposure to the elements and do not allow water to enter the controller.
- Install the ProStar in a location that prevents casual contact. The ProStar heatsink can become very hot during operation.
- Use insulated tools when working with batteries.
- Avoid wearing jewelry during installation.
- The battery bank must be comprised of batteries of same type, make, and age.
- UL/IEC 62109 certified for use in negative ground or

floating systems only.

- Do not smoke near the battery bank.
- Power connections must remain tight to avoid excessive heating from a loose connection.
- Use properly sized conductors and circuit interrupters.
- The grounding terminal is located in the case, and is identified by the symbol below:

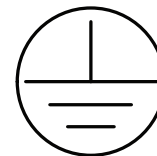

Ground Symbol

- This charge controller is to be connected to DC circuits only. These DC connections are identified by the symbol below:



Direct Current Symbol

The ProStar controller must be installed by a qualified technician in accordance with the electrical regulations of the country of installation.

A means of disconnecting all power supply poles must be provided. These disconnects must be incorporated in the fixed wiring.

The ProStar negative power terminals are common, and must be grounded as instructions, local codes, and regulations require.

A permanent, reliable earth ground must be established with connection to the ProStar ground terminal.

The grounding conductor must be secured against any accidental detachment.

### Précautions de Sécurité D'installation

---



**AVERTISSEMENT:** *L'appareil n'est pas fourni avec un dispositif GFDI. Ce contrôleur de charge doit être utilisé avec un dispositif GFDI externe comme requis par le code local ou les réglementations*

- Montez le ProStar à l'intérieur. Empêchez l'exposition aux éléments et la pénétration d'eau dans le contrôleur.
- Installez le ProStar dans un endroit qui empêche le contact occasionnel. Le dissipateur de chaleur ProStar peut devenir très chaud pendant le fonctionnement.
- Utilisez des outils isolés pour travailler avec les

batteries.

- Évitez le port de bijoux pendant l'installation.
- Le groupe de batteries doit être constitué de batteries du même type, fabricant et âge.
- UL/IEC 62109 certifié pour utilisation au négatif à la masse ou les systèmes flottants seulement.
- Ne fumez pas à proximité du groupe de batteries.
- Les connexions d'alimentation doivent rester serrées pour éviter une surchauffe excessive d'une connexion desserrée.
- Utilisez des conducteurs et des coupe-circuits de dimensions adaptées.
- La borne de mise à la terre se trouve dans l'affaire et est identifié par le symbole ci-dessous :

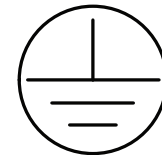

- Ce contrôleur de charge ne doit être connecté qu'à des circuits en courant continu. Ces connexions CC sont identifiées par le symbole ci-dessous:



Le régulateur ProStar doit être installé par un technicien qualifié conformément aux règlements du pays

d'installation électriques.

Un moyen de déconnexion de tous les poteaux d'alimentation doit être fourni. Ceux-ci se déconnecte doit être intégrée dans le câblage fixe.

Une mise à la terre permanent et fiable s'impose avec raccordement à la borne ProStar.

Les bornes de puissance négative ProStar sont communs et doivent être mise à la terre comme les directives, les codes locaux, et les règlements exigent.

Le conducteur de terre doit être protégée contre tout détachement accidentel.

## Battery Safety

.....



**WARNING:** A battery can present a risk of electrical shock or burn from large amounts of short-circuit current, fire, or explosion from vented gases. Observe proper precautions.



**AVERTISSEMENT :** Une batterie peut présenter a risque de choc électrique ou de brûlure de grandes quantités de court-circuit curlouer, incendie ou explosion de ventilé gaz. Observer précautions appropriées.



**WARNING: Risk of Explosion.**  
Proper disposal of batteries is required. Do not dispose of batteries in fire. Refer to local regulations or codes for requirements.



**AVERTISSEMENT : Risque d'Explosion.**  
Au rebut des piles est nécessaire. Ne pas jeter les piles dans le feu. Se référer aux réglementations locales ou des codes pour les exigences.



**CAUTION:** When replacing batteries, use properly specified number, sizes, types, and ratings based on application and system design.



**PRUDENCE:** Lorsque le remplacement des piles, utilisez correctement nombre spécifié, tailles, types et les évaluations basées sur conception de système et d'application.



**CAUTION:** Do not open or mutilate batteries. Released electrolyte is harmful to skin, and may be toxic.



**PRUDENCE:** Ne pas ouvrir ou mutiler les piles. L'électrolyte est nocif pour la peau et peut être toxique.

- Servicing of batteries should be performed, or supervised, by personnel knowledgeable about batteries, and the proper safety precautions.
- Be very careful when working with large lead-acid batteries. Wear eye protection and have fresh water available in case there is contact with the battery acid.
- Remove watches, rings, jewelry and other metal objects before working with batteries.
- Wear rubber gloves and boots

- Use tools with insulated handles and avoid placing tools or metal objects on top of batteries.
- Disconnect charging source prior to connecting or disconnecting battery terminals.
- Determine if battery is inadvertently grounded. If so, remove the source of contact with ground. Contact with any part of a grounded battery can result in electrical shock. The likelihood of such a shock can be reduced if battery grounds are removed during installation and maintenance (applicable to equipment and remote battery supplies not having a grounded supply circuit).
- Carefully read the battery manufacturer's instructions before installing / connecting to, or removing batteries from, the ProStar.
- Be very careful not to short circuit the cables connected to the battery.
- Have someone nearby to assist in case of an accident.
- Explosive battery gases can be present during charging. Be certain there is enough ventilation to release the gases.
- Never smoke in the battery area.
- If battery acid comes into contact with the skin, wash with soap and water. If the acid contacts the eye, flood with fresh water and get medical attention.

- Be sure the battery electrolyte level is correct before starting charging. Do not attempt to charge a frozen battery.
- Recycle the battery when it is replaced.
- Entretien des batteries devrait être effectué ou supervisé, par un personnel bien informé sur les piles et les précautions de sécurité appropriées.
- Soyez très prudent quand vous travaillez avec des grandes batteries au plomb. Portez des lunettes de protection et ayez de l'eau fraîche à disposition en cas de contact avec l'électrolyte.
- Enlevez les montres, bagues, bijoux et autres objets métalliques avant de travailler avec des piles.
- Porter des bottes et des gants de caoutchouc
- Utiliser des outils avec poignées isolantes et évitez de placer des outils ou des objets métalliques sur le dessus de batteries.
- Débrancher la source de charge avant de brancher ou dis-reliant les bornes de la batterie.
- Utilisez des outils isolés et évitez de placer des objets métalliques dans la zone de travail.



- Déterminer si batterie repose par inadvertance. Dans l'affirmative, supprimer la source du contact avec le sol. Contact avec n'importe quelle partie d'une batterie mise à la terre peut entraîner un choc électrique. La probabilité d'un tel choc peut être réduite si des motifs de batterie sont supprimés pendant l'installation et maintentretien (applicable à l'équipement et les fournitures de pile de la télécommande n'ayant ne pas un circuit d'alimentation mise à la terre).
- Lisez attentivement les instructions du fabricant de la batterie avant d'installer / connexion à ou retrait des batteries du ProStar.
- Veillez à ne pas court-circuiter les câbles connectés à la batterie.
- Ayez une personne à proximité qui puisse aider en cas d'accident.
- Des gaz explosifs de batterie peuvent être présents pendant la charge. Assurez-vous qu'une ventilation suffisante évacue les gaz.
- Ne fumez jamais dans la zone des batteries
- En cas de contact de l'électrolyte avec la peau, lavez avec du savon et de l'eau. En cas de contact de l'électrolyte avec les yeux, rincez abondamment avec de l'eau fraîche et consultez un médecin.
- Assurez-vous que le niveau d'électrolyte de la batterie est correct avant de commencer la charge. Ne tentez pas de charger une batterie gelée.
- Recyclez la batterie quand elle est remplacée.

## 2.0 GENERAL INFORMATION

### 2.1 Overview

Thank you for choosing the ProStar solar charge controller.

The ProStar battery charging process has been optimized for long battery life and improved system performance. Self-diagnostics and electronic error protections prevent damage when installation mistakes or system faults occur. The controller also features eight (8) adjustable settings switches, a communication port, and terminals for remote battery temperature and voltage measurement.

Please take the time to read this operator's manual to become familiar the many benefits the ProStar can provide for your PV systems, for example:

- Rated for 12 or 24 Volt systems, and 15 or 30 Amps of charging current
- Fully protected with automatic and manual recovery
- Seven standard charging programs selectable with DIP switches
- Continuous self-testing with fault notification
- LED indications and optional meter monitoring
- Terminals sized for #14-6 AWG (2.5-13.3 mm<sup>2</sup>) wire
- Includes battery voltage sense terminals
- Optional remote battery temperature sensor
- 5-year warranty (see Section 6.0)

## 2.2 Regulatory Information

---



**NOTE:** This section contains important information on regulatory requirements.

ProStar controllers comply with the following European (ENs) standards:

- Immunity: EN 61000-4-3: 2006  
EN 61000-4-6: 2009
- Immunity: EN 61000-6-2: 2005/AC:2005 EMC
- Emissions: EN 61000-6-4: 2007 +A1:2011 EMC

### FCC Requirements:

This device complies with Part 15 of the FCC rules. Operation is subject to the following two conditions: (1) This device may not cause harmful interference, and, (2) this device must accept any interference received, including interference that may cause undesired operation.

Changes or modifications not expressly approved by Morningstar, for compliance, could void the user's authority to operate the equipment.



**NOTE:** This equipment has been tested and found to comply with the limits for a Class B digital device, pursuant to Part 15 of the FCC rules. These limits are designed to provide reasonable protection against harmful interference in a residential installation. This equipment generates, uses, and can radiate radio frequency energy and, if not installed and used in accordance with the instruction manual, may cause harmful interference to radio communication. However, there is no guarantee that interference will not occur in a particular installation. If this equipment does cause harmful interference to radio or television reception, which can be determined by turning the equipment on and off, the user is encouraged to try to correct the interference by one or more of the following measures:

- Re-orient or relocate the receiving antenna.
- Increase the separation between the equipment and receiver.
- Connect the equipment into an outlet on a circuit different from that to which the receiver is connected.
- Consult the dealer, or an experienced radio/TV technician for help.

This Class B digital apparatus complies with Canadian ICES-003.

## 2.3 Features

The features of the ProStar are shown in Figures 2-1, 2.2 and 2.3 below. An explanation of each feature follows.

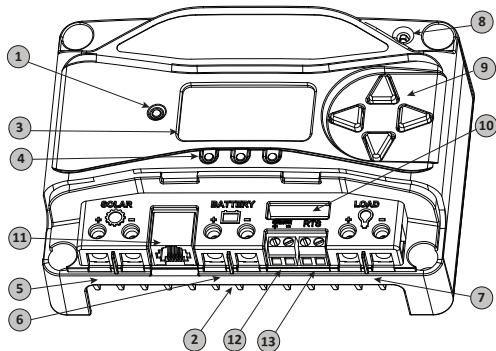

Figure 2.1. ProStar Features

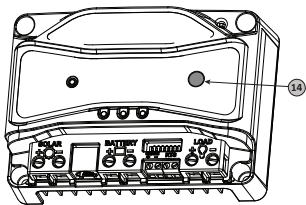

Figure 2.2. Non-Metered Unit Push-Button

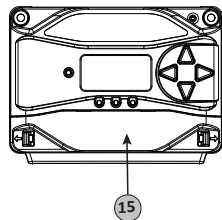

Figure 2.3. Removable Terminal Cover

### 1 - Charging Status / Error LED

Shows charging current and error condition statuses.

### 2 - Heatsink

Aluminum heatsink (underneath) to dissipate controller heat (the ProStar is 100% passively cooled for reliability)

### 3 - Meter Display (optional)

Digital LCD monitoring and programming display

### 4 - Battery Status / Fault LED Indicators

Three state of charge (SOC) LED indicators show charging status and controller faults

### 5 - Solar Positive and Negative Terminals

Power connections for Solar (+) and (-) cable terminations

### 6 - Battery Positive and Negative Terminals

Power connections for Battery (+) and (-) cable terminations

### 7 - Load Positive and Negative Terminals

Power connections for Load (+) and (-) cable terminations

### 8 - Local Temperature Sensor

Compensates charging based on ambient temperature, in absence of Remote Temperature Sensor

### 9 - Meter Directional Buttons

Used to navigate throughout the meter map

### 10 - DIP Switches

Eight (8) settings switches to configure operation of the ProStar

## 11 - MeterBus™ Port

RJ-11 socket for Morningstar MeterBus™ network connections

## 12 - Battery Sense Terminals

Connection points for battery voltage sensing wires

## 13 - Remote Temperature Sensor Terminals (RTS)

Connection points for a Morningstar RTS to remotely monitor battery temperature

## 14 - Push-button (non-metered version)

Initiates manual Equalization, clears any faults or reminders, conducts a lighting test, restores settings to factory default

## 15 - Removable Terminal Cover

Cover protects circuit board and termination points

## 2.4 Optional Accessories

The following accessories are available for purchase separately from your authorized Morningstar dealer:

### **Remote Temperature Sensor (Model: RTS)**

The RTS measures battery temperature for accurate temperature compensation and is recommended when the ambient battery temperature differs from the ambient controller temperature by +/- 5° C or more. An RTS can be attached to the ProStar at any time. The ProStar will automatically use the RTS for battery temperature compensation when installed. The standard cable length is 33 ft (10m), and can be extended to 100 ft (30m) if required. Installation instructions are provided with the RTS.



**NOTE:** *The use of a Remote Temperature Sensor (RTS) is strongly recommended.*

*Controller location, air flow, and system power can drastically affect the local temperature sensor reading. An RTS will provide optimal charging performance.*

### **RM-1 Meter**

A remote meter for monitoring system variables, for use through the ProStar Meterbus port.

### **Ground-fault Protection Device (GFPD-150V)**

The GFPD-150V detects power source ground faults and interrupts current as required by the US National Electrical Code.

### **Communications Support:**

#### **Ethernet MeterBus Converter (EMC-1)**

This product is an Ethernet gateway that provides web monitoring services, a Modbus TCP/IP server, and a local web page server. End users can collect information about their off-grid PV system remotely. One EMC-1 supports all products with MeterBus ports by bridging MODBUS TCP/IP requests to serve LiveView pages for each product.

#### **USB Communications Adapter (UMC-1)**

A modular unit that uses a USB-B plug, usually from a USB A-B computer cable, and an RJ-11 plug to connect with a Morningstar controller's MeterBus port, for monitoring and programming using MSView PC software.

### 3.1 General Installation Notes

#### PC MeterBus Adapter™ (Model: MSC)

The MSC converts the MeterBus RJ-11 electrical interface to an isolated standard RS-232 interface which enables communication between the ProStar and a PC. The MSC can be used for programming custom charging set-points, and for logging data in MSView. See Section 4.5 for more information on programming.

- Read through the entire installation section first before beginning installation.
- Do not install in locations where water can enter the controller.
- Loose power connections and/or corroded wires may result in resistive connections that melt wire insulation, burn surrounding materials, or even cause fire. Ensure tight connections and use cable clamps to secure cables and prevent them from swaying in mobile applications.



#### **CAUTION: Equipment Damage**

*When installing the ProStar in an enclosure, ensure sufficient ventilation. Installation in a sealed enclosure may lead to over-heating and a decreased product lifetime.*



#### **PRUDENCE : Dommages à l'équipement**

*Assurez une ventilation suffisante en cas d'installation du ProStar dans une enceinte. L'installation dans une enceinte hermétique peut entraîner une surchauffe et une réduction de la durée de vie du produit.*

- Preset charging profiles are generally designed for lead acid batteries. Custom settings can be used for varied charging requirements (see sections 3.2 and 4.5 for details). Note that some battery types may not be compatible.
- The ProStar battery connection may be wired to one battery or a bank of batteries. The following instructions refer to a singular battery,

but it is implied that the battery connection can be made to either one battery or a group of batteries in a battery bank.

- The ProStar uses stainless steel fasteners, an anodized aluminum heat sink, and conformal coating to protect it from harsh conditions. However, for acceptable service life, extreme temperatures and marine environments should be avoided.
- The ProStar prevents reverse current leakage at night, so a blocking diode is not required in the system.
- The ProStar is designed to regulate ONLY solar (photovoltaic) power. Connection to any other type of power source e.g. wind turbine or generator may void the warranty. However, other power sources may be connected directly to the battery.
- The connector terminals will accept a maximum wire size of AWG #6 / 13.3 mm<sup>2</sup> (multi-strand). Use an insulated flathead screwdriver, and torque tightly up to 35 in-lb (4 N-m).



**CAUTION:**

*For hazardous location-IECEX/ATEX applications, see the addendum - part no. MS-003245-EN - to this manual.*



**PRUDENCE:**

*Pour les applications en environnement dangereux - IECEX / ATEX, voir l'addendum - référence MS-003245-FR - à ce Manuel.*



**WARNING: Shock and Fire Hazard**

*Battery, load and PV array disconnects and overcurrent protection are required in the system. These protection devices are external to the ProStar PWM controller.*



**AVERTISSEMENT : Risque d'électrocution et d'incendie**

*Des déconnexions de batterie, de charge et de générateur photovoltaïque et une protection contre les surintensités sont nécessaires dans le système. Ces dispositifs de protection sont externes au contrôleur ProStar PWM.*



**WARNING: Shock and Fire Hazard**

*All breakers must be properly sized based on maximum circuit current.*



**AVERTISSEMENT : Risque d'électrocution et d'incendie**

*Tous les disjoncteurs doivent être correctement dimensionnés en fonction du courant maximal du circuit.*



**WARNING: Shock and Fire Hazard**

*Minimum over-current protection device interrupt ratings must be 2000A for 12V systems, and 4000A for 24V systems.*



**AVERTISSEMENT : Risque d'électrocution et d'incendie**

*Les valeurs nominales minimales d'interruption du dispositif de protection contre les surintensités doivent être de 2 000 A pour les systèmes 12 V et de 4 000 A pour les systèmes 24 V.*



**NOTE: Carefully observe the LEDs after each connection.**

*The LEDs will indicate proper polarity, and a secure connection.*

## 3.2 Configuration

The DIP switch block shown in Figure 3.1 below is used to set the operating parameters for the ProStar.

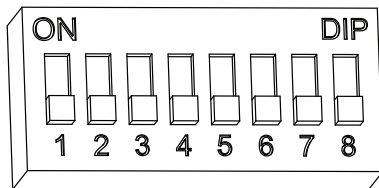

Figure 3.1. DIP Switch Block to set charging parameters

### Switch 1: Load / Lighting

Mode	Switch 1
Normal	OFF
Lighting	ON

### Switches 2, 3: System Voltage

Three (3) system voltage configurations are available as shown in the table below:

System voltage	Switch 2	Switch 3
Auto	OFF	OFF
12	OFF	ON
24	ON	OFF

 **NOTE:** Before connecting the battery, measure the open-circuit voltage. It must be over 10 Volts to start the controller. If the system voltage DIP Settings Switches are set to Auto-detect, battery voltage over 15.5V will be detected as a 24V nominal battery, and the unit will charge accordingly. The 12/24V auto selection is only done at start-up, and the detected system voltage will never change during operation.

It is recommended to set DIPs 2 and 3 to the correct system voltage setting. Only use the default auto-detect setting if the nominal system voltage is not known.

### Switches 4, 5, 6: Battery Type Selection

Preset ProStar battery charging options are shown in table 3-1 below. All voltage settings listed are for nominal 12 Volt batteries. Multiply the voltage settings by two (2) for 24 Volt systems.

 **NOTE:** The charging profiles below are general guidelines for use at the operator's discretion. Consult the battery manufacturer for optimal battery charge settings.

### Battery Charging Set-points (@ 25°C):

[multiply voltages by (2) for 24 Volt systems]

DIP Switch Settings 4-5-6	Battery Type	Absorp. Stage (volts)	Float Stage (volts)	Equalize Stage (volts)	Absorp. Time (mins)	Equalize Time (mins)	Equalize Timeout (mins)	Equalize Interval (days)
off-off-off	1 - Sealed*	14.00	13.50		150			
off-off-on	2 - Sealed*	14.15	13.50	14.40	150	60	120	28
off-on-off	3 - Sealed*	14.30	13.50	14.60	150	60	120	28
off-on-on	4 - AGM/Flooded	14.40	13.50	15.10	180	120	180	28
on-off-off	5 - Flooded	14.60	13.50	15.30	180	120	180	28
on-off-on	6 - Flooded	14.70	13.50	15.40	180	180	240	28
on-on-off	7 - L-16	15.40	13.40	16.00	180	180	240	14
on-on-on	8 - Custom	Custom	Custom	Custom	Custom	Custom	Custom	Custom

\* "Sealed" battery type includes gel and AGM batteries

### Switch 7: Battery Equalization

Mode	Switch 7
Manual Equalization	OFF
Auto Equalization	ON

### Switch 8: Current Switching

Mode	Switch 8
PWM switching	OFF
Slow switching	ON

The default (PWM) switching setting (OFF / down) operates at 300Hz. If load or system noise is an issue, DIP 8 can be set (ON-up) for slow switching at 1Hz. Standard PWM switching is recommended when system noise is not a problem.

## 3.3 Mounting

Inspect the controller for shipping damage.

Mount the ProStar to a vertical surface (4-#8 stainless steel self-tapping screws are included). Tighten the mounting screws using care not to crack the plastic case.

Do not install directly over an easily combustible surface since the heat sink may get hot under certain operating conditions.



**NOTE:** The heat sink must be in a vertical position (fins up and down).

For proper air flow, allow at least 15 cm (6 in) of space above and below the controller, and 50 mm (2 in) at the sides - see Figure 3-2 below. Do not locate in an enclosure where battery gases can accumulate.

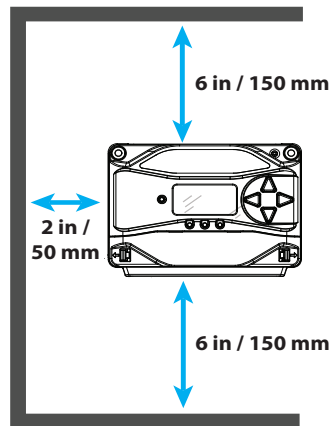

Figure 3-2. Proper Clearances for Passive Cooling

## 3.4 Wiring

### 3.4.1 Wire Sizing



#### **CAUTION: Code Requirements**

U.S. installed wiring must conform to all current U.S. NEC, ANSI/NFPA 70 requirements, and to any local regulations. Non-U.S. installations must meet all national and local requirements of the country of installation.





### **PRUDENCE : Exigences du Code**

*Le câblage installé aux États-Unis doit être conforme à toutes les exigences actuelles du NEC américain, ANSI/NFPA 70 et à toute réglementation locale. Non américain les installations doivent répondre à toutes les exigences nationales et locales du pays d'installation.*

The power terminals are sized for #14 - 6 AWG (2.5 - 13.3 mm<sup>2</sup>) wire. Use an insulated 3/16" (4.76 mm) flathead screwdriver, and torque tightly up to 35 in-lb (4 N-m).

The terminals are rated for copper and aluminum conductors. Use UL-listed Class B or Class C stranded wire rated for 300 Volt and 75C or higher. Copper is recommended due to the ease of use, good conductivity, strength and lower thermal expansion properties.

It is critical that the ampacity (current carrying capacity) of conductors is sufficient to allow the maximum current of the power circuits. The ProStar power terminals are rated for 75°C. When wires with a 90°C temperature rating are used with terminals that have a 75°C temperature rating, wire ampacity at 75°C must be used. This also applies to the temperature ratings of breaker and disconnect terminals.

The controller battery and load wire ampacity must be greater than or equal to 125% of current rating of the ProStar controller. Minimum battery wire sizes are as follows:

ProStar-15/M: #12 AWG (4 mm<sup>2</sup>) or #10 AWG (6 mm<sup>2</sup>) if greater than 50°C inside conduit

ProStar-30/M: #8 AWG (10 mm<sup>2</sup>) or #10 AWG (6 mm<sup>2</sup>) if greater than 50°C inside conduit.

NOTE: For smaller load breakers or fuses, a smaller wire size can be used. The minimum wire sizes based on breaker or fuse current rating are as follows:

#14 AWG with 15A breakers or fuses

#16 AWG with 10A breakers or fuses (less than 8A maximum continuous current)

#18 AWG with less than 7A breakers or fuses (less than 5.6A maximum continuous current)

The PV input wire ampacity must be greater than or equal to 156% of PV Array Isc without correction and adjustment factors, and also greater than or equal to 125% of PV Array Isc after correction and adjustment factors.

Wire ampacity correction and adjustment factors may also be required to account for the following:

- temperatures at different parts of the circuit (roof-tops or engine rooms, for example)
- wire terminal temperature ratings
- multi-conductor cables
- conduit fill and other factors

Good system design generally requires large conductors/wires that limit voltage drop losses to 2% or less.

See Appendix B - Voltage Drop (distances) Tables - for minimum copper wire sizing to achieve maximum 2% voltage drops.



**WARNING: Fire Hazard**

If multiple units are used in parallel for more charging current, the battery conductor wiring must be sized for the total sum of all current ratings of the combined controllers.



**AVERTISSEMENT : Risque d'incendie**

Si plusieurs unités sont utilisées en parallèle pour plus de courant de charge, le câblage du conducteur de la batterie doit être dimensionné pour la somme totale de tous les courants nominaux des contrôleurs combinés.

**3.4.2 Required Overcurrent Protection Devices (OCPDs) and Disconnect Switches**



**WARNING: Fire Hazard**

Battery, load and PV array overcurrent protection (breakers or fuses) are required in the system. These protection devices are external to the ProStar controller, and must be sized as required by the US NEC, local or country of installation code requirements.



**AVERTISSEMENT : Risque d'incendie**

Surintensité de la batterie, de la charge et du générateur photovoltaïque protection (disjoncteurs ou fusibles) sont nécessaires dans le système. Ces dispositifs de protection sont externes au contrôleur ProStar et doivent être dimensionnés conformément aux exigences du NEC ou du code local.



**WARNING: Shock Hazard**

The PV system requires a means of disconnecting the battery, load and PV array.

Breaker switches or disconnect switches can serve as a disconnecting means and should be located at readily accessible locations. For best practices and safety guidance see NEC 690 "Part III - Disconnecting Means" for disconnect requirements for PV systems in addition to other code requirements.



**AVERTISSEMENT : Risque d'électrocution**

Le système PV nécessite un moyen de déconnecter la batterie, la charge et le générateur PV. Les disjoncteurs ou les sectionneurs peuvent servir de moyens de déconnexion et doivent être situés à un endroit facilement accessible. Pour les meilleures pratiques et les conseils de sécurité, voir NEC 690 "Partie III - Disconnecting Means" pour les exigences de déconnexion des systèmes PV en plus des autres exigences du code.



**WARNING: Shock Hazard**

Fuses, single-pole circuit breakers, or single-pole disconnect switches must only be installed on ungrounded system conductors. The NEC allows, and may require, the use of double-pole breakers or double-pole disconnect switches which break both the grounded and ungrounded conductors of the PV array.



**AVERTISSEMENT : Risque d'électrocution**

Les fusibles, les disjoncteurs unipolaires ou les sectionneurs unipolaires ne doivent être installés que sur des conducteurs de système non mis à la terre. Le NEC autorise et peut exiger l'utilisation de disjoncteurs bipolaires ou de sectionneurs bipolaires qui coupent à la fois les conducteurs mis à la terre et non mis à la terre du générateur photovoltaïque.

## BATTERY DISCONNECT AND OVER-CURRENT PROTECTION DEVICE SIZING

The U.S. NEC requires the installation of DC breakers or fused disconnect switches in all battery circuits in order to provide both a means of disconnection and overcurrent protection.

The battery breaker or fused disconnect switch(es) should be located near the battery or the battery busbar. Where the controller battery terminals are more than 1.5m (5 feet) from the battery, or where circuits from these terminals pass through a wall or partition, U.S. NEC requires that a means of disconnection be provided at the battery and solar controller.

The minimum battery disconnect switch current rating is the current rating of the controller being installed. To provide over-current protection when using a disconnect switch, a properly sized fuse or breaker must be installed in series.

Battery breakers or fuses must be sized with a minimum of 125% of the continuous output current rating of the solar controller. Recommended battery circuit fuse or breaker current ratings:

ProStar-15/M: 20 Amps  
ProStar-30/M: 40 Amps

## PV INPUT DISCONNECT AND OVER-CURRENT PROTECTION DEVICE SIZING



### **WARNING: Shock and Fire Hazards**

The solar array open-circuit voltage (Voc) at the worst-case (coldest) module temperature must not exceed the PV disconnect or overcurrent protection voltage ratings.



### **AVERTISSEMENT : Risques d'électrocution et d'incendie**

*La tension en circuit ouvert du générateur solaire (Voc) à la température de module la plus défavorable (la plus froide) doit ne pas dépasser les valeurs nominales de tension de déconnexion PV ou de protection contre les surintensités.*

As defined in NEC Section 690.9, PV input disconnect switches must have a current rating greater than or equal to the maximum PV array current (1.25 x PV array Isc). **PV array Isc equals the number of strings multiplied by the module Isc (STC) rating.** Note that individual PV string circuits do not require disconnects.

NEC Section 690.9 also provides requirements for over-current protection. The PV input breaker or fuse current rating should not be less than the next higher breaker rating above 125% of the maximum PV array current (156% of the PV array Isc). Maximum PV breaker or fuse ratings are:

ProStar-15 / M: 20 Amps

ProStar-30 / M: 40 Amps

String over-current protection is also required for parallel strings, and are typically included with the PV string combiner.

There may be other code requirements specific to the installation of a particular PV array.

### LOAD DISCONNECT AND OVER-CURRENT PROTECTION DEVICE SIZING

The load output breaker or fused disconnect switch should be near the load output terminals of the controller. A load fuse should be installed between the controller output and the load disconnect.

The load output disconnect switch must have a minimum current rating greater than or equal to the fuse current rating but is not required to be higher than the load output current rating of the controller.

The load fuse or breaker should be sized at a minimum of 125% of the maximum continuous load output current. The maximum load output current is the sum of the branch load circuits or the controller load output current rating.

The maximum load output breaker or fuse current rating is:

ProStar-15/M: 20 Amps

ProStar-30/M: 40 Amps

### 3.4.3 Wiring Connections

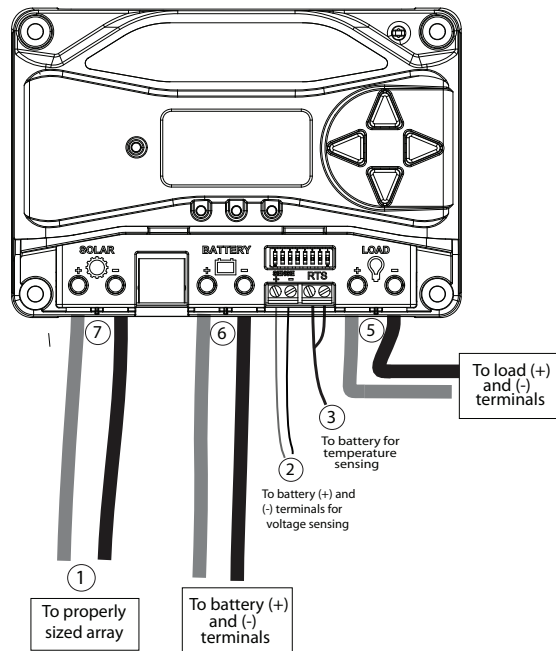

Figure 3-3. Wiring the ProStar

REFER TO FIGURE 3.3 WHEN USING THE WIRING INSTRUCTIONS BELOW

## STEP 1: Check Controller Limitations

Verify that the highest temperature compensated solar array open-circuit voltage (Voc), and load current do not exceed the ratings of the ProStar version being installed.

Multiple controllers can be installed in parallel on the same battery bank to achieve greater total charging current. In this type of system, each ProStar must have its own solar array. The load terminals of multiple controllers can only be wired together if the total load draw does not exceed the nameplate current of the LOWEST rated controller.

## STEP 2: Battery Voltage Sense Wires



### **WARNING: Fire Hazard**

*When connecting battery sense wires, install a 5 Amp fuse in the (+) sense wire, six inches from the (+) battery terminal.*



### **AVERTISSEMENT : Risque d'incendie**

*Lors de la connexion des câbles de détection de batterie, installez un Fusible de 5 A dans le fil de détection (+), à six pouces de la borne (+) de la batterie.*

Due to connection and cable resistance, voltage drops are unavoidable in power cables that carry current, including the ProStar battery cables. If battery sense wires are not used, the controller must use the voltage reading at the controller's battery power terminals for regulation. This voltage will be higher than the actual battery bank voltage while charging the battery.

Generally accepted wiring practice is to limit voltage drops between the charger and the battery to 2%. Even properly sized wiring with 2% drop can result in a 0.29 Volt drop for 14.4V charging. Voltage drops will cause some undercharging of the battery. The controller will begin Absorption or limit equalization at a lower battery voltage because the controller measures a higher voltage at the controller's terminals than is the actual battery voltage. For example, if the controller is programmed to start Absorption at 14.4V, when the controller "sees" 14.4V at its battery terminals, the true battery voltage would only be 14.1V, if there is a 0.3V drop between the controller and battery.

Note that the battery sense wires will not power the controller, and the sense wires will not compensate for losses in the power wires between the controller and the battery. The battery sense wires are used to improve the accuracy of the battery charging.

The two sense wires, can range in size from 1.0 to 0.25 mm<sup>2</sup> (16 to 24 AWG), and should be cut to length as required to connect the battery to the voltage sense terminals. A 2-position terminal (see Figure 3.3) is used for the battery sense connection. A twisted pair cable is recommended but not required. Use UL rated 300 Volt conductors. The voltage sense wires may be pulled through conduit with the power conductors.

Observing correct polarity, connect both battery voltage sense wires to the ProStar at the 2-position Battery Sense Terminal, and to battery (+) and (-)

terminals. No damage will occur if the polarity is reversed, but the controller cannot read a reversed sense voltage.

Tighten the connector screws to 5 in-lb (0.56 Nm) of torque.

The maximum length allowed for each battery voltage sense wire is 98 ft (30m).

Connecting the voltage sense wires to the RTS terminals will cause an alarm.



**NOTE:** *If the battery input voltage is greater than 5 Volts different than the Battery Sense, due to voltage drops or faulty connections, the Battery Sense input will not be recognized by the ProStar.*

A battery voltage sense connection is not required to operate the ProStar controller, but it is recommended for best performance.

The battery voltage sense wires enable the ProStar to measure the voltage at the battery terminals accurately with no voltage drop.

### STEP 3: Remote Temperature Sensor



**WARNING: Risk of Fire** *If no Remote Temperature Sensor (RTS) is connected, use the ProStar within 3m (10 ft) of the batteries. Internal Temperature Compensation will be used if the RTS is not connected. Use of the RTS is strongly recommended.*



### AVERTISSEMENT : Risque d'incendie

Si aucun capteur de température à distance (RTS) n'est connecté, utilisez le ProStar à moins de 3 m (10 pieds) des piles. La compensation de température interne sera utilisée si le RTS n'est pas connecté. L'utilisation du RTS est fortement recommandée.

All charging settings are based on 25°C (77°F). If the battery temperature varies by 5°C, the charging setting will change by 0.15 Volts for a 12 Volt battery.

This is a substantial change in the charging of the battery, and the use of the optional Remote Temperature Sensor (RTS) is recommended to adjust charging to the actual battery temperature.

The need for temperature compensation depends on the temperature variations, battery type, how the system is used, and other factors. If the battery appears to be gassing too much or not charging enough, the RTS can be added at any time after the system has been installed.

Connect the RTS to the 2-position terminal located to the left of the (+) Load terminal (see Figure 3.3).

The RTS is supplied with 33 ft (10 m) of 22 AWG (0.34 mm<sup>2</sup>) cable. There is no polarity, so either wire (+ or -) can be connected to either screw terminal. The RTS cable may be pulled through conduit along with the power wires. Tighten the connector screws to 5 in-lb (0.56 Nm) of torque. Separate installation instructions are provided inside the RTS bag.

 **CAUTION: Equipment Damage**  
Never place the temperature sensor inside a battery cell. Both the RTS and the battery will be damaged.

 **ATTENTION : Dommages matériels**  
Ne placez jamais le capteur de température dans un cellule de batterie. Le RTS et la batterie sera endommagé.

 **CAUTION:** The ProStar will use the local temperature sensor for compensation if the RTS is not used.

 **PRUDENCE :** Le ProStar utilisera le capteur de température pour la compensation si le RTS n'est pas utilisé.

 **NOTE:** The RTS cable may be shortened if the full length is not needed. Be sure to re-install the ferrite choke on the end of the RTS if a length of cable is removed. This choke ensures compliance with electromagnetic emissions standards.

#### STEP 4: Grounding

 **NOTE:** Depending on the country of installation, conductors identified by the color green, or a combination of green /yellow, shall only be used as earthing conductors.

For safety, and effective lightning protection, it is recommended, and may be locally required, that the negative conductor of the charging system be properly grounded. For conductor sizing requirements, refer to the US National Electrical Code, or applicable local regulations or code.

 **WARNING: Risk of Fire**  
DO NOT bond DC system electrical negative to earth grounding terminal on the controller. Per NEC, system negative must be bonded to earth ground at only one point, and through a GFPD, if required.

 **AVERTISSEMENT : Risque d'incendie**  
NE PAS relier le négatif électrique du système CC à la borne de mise à la terre du contrôleur. Si requis par le code ou la réglementation locale, le négatif du système doit être relié à la terre en un seul point et via un GFPD.

#### STEP 5: Battery Connections - see diagram below

Be sure that DIP switches 2 and 3 are set for 12 or 24V, as described in Section 3.2.

 **NOTE:** Before connecting the battery, measure the open-circuit voltage. It must be over 10 Volts to start the controller. If the system voltage Settings Switches are set to Auto-detect, battery voltage over 15.5V will be detected as a 24V nominal battery, and the unit will charge accordingly. The 12/24V auto selection is only done at start-up.

Install an OPEN battery OCPD, and connect the battery wires - observing correct polarity - as shown below. **DO NOT CLOSE THE BATTERY OCPD AT THIS TIME.**



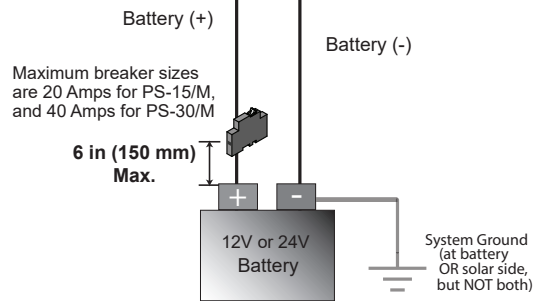
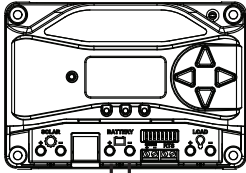

**⚡ WARNING: Shock Hazard**  
 The solar PV array can produce open-circuit voltages of up to 60 Vdc when in sunlight, and this DC voltage is supplied to the Power Conversion Equipment (PCE). Verify that the solar input breaker or disconnect has been opened (disconnected) before installing the system wires.

**⚡ AVERTISSEMENT : Risque d'électrocution**  
 Le générateur solaire photovoltaïque peut produire des tensions en circuit ouvert allant jusqu'à 60 Vcc lorsqu'il est exposé au soleil, et cette tension continue est fournie à l'équipement de conversion

de puissance (PCE). Vérifiez que le disjoncteur ou le sectionneur d'entrée solaire a été ouvert (déconnecté) avant d'installer les câbles du système.

**STEP 6: Solar Connections - see diagram below**

Install an OPEN solar OCPD, and connect the solar wires - observing correct polarity - as shown below. Use caution, since the solar array will produce current whenever in sunlight. **DO NOT CLOSE THE OCPD AT THIS TIME.**

**NOTE:** For design purposes, array should be nominal 12V for 12V battery, and nominal 24V for 24V battery. Do not exceed 60Voc

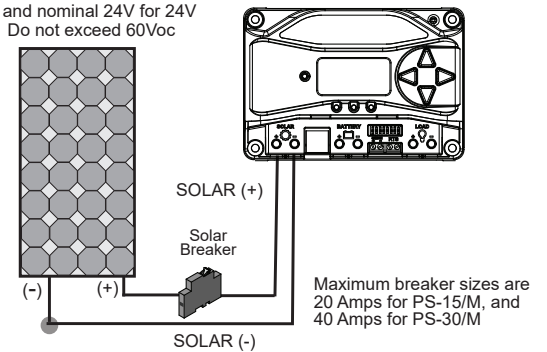

**STEP 7: Load Connections - see diagram below**

**⚠ CAUTION: Equipment Damage**  
 Do not wire any AC inverter to the load terminals of the ProStar. Damage to the load control circuit may result. An inverter should be wired directly to the battery. If there is a possibility that



any other load, e.g., pumps or motors, will sometimes exceed the ProStar's maximum voltage or current limits, the device should be wired directly to the battery/battery bank. If load control is required, contact Morningstar Technical Support for assistance.



### **ATTENTION : Dommages matériels**

Ne connectez aucun onduleur CA à la charge terminaux du ProStar. Cela pourrait endommager le circuit de commande de charge. Un onduleur doit être connecté directement à la batterie. S'il y a une possibilité qu'une autre charge, par ex. pompes ou moteurs, dépassent parfois la tension maximale ou les limites de courant du Prostar, l'appareil doit être connecté directement à la batterie / banque de batteries. Si un contrôle de charge est nécessaire, contactez l'assistance technique Morningstar pour obtenir de l'aide.

With the loads off, install an OPEN load OCPD, and connect the load wires - observing correct polarity - as shown below. **DO NOT CLOSE THE OCPD AT THIS TIME.**

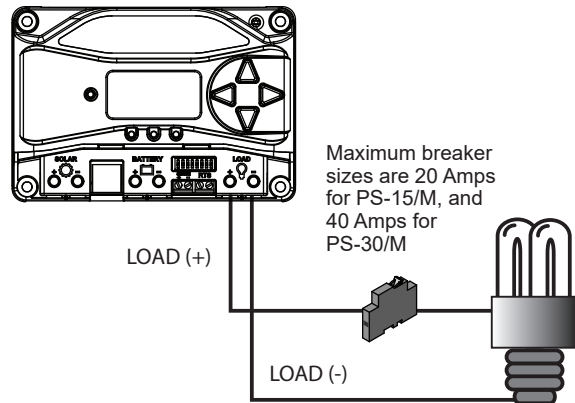

### **STEP 8: Power-Up and Verify System Operation**

Close the battery disconnect to start the processor, and activate the controller's protections. Watch the charging status, and then the three battery state-of-charge (SOC) LEDs blink in sequence (G-Y-R), confirming proper start-up. If they do not light, check the battery polarity (+/-) and battery voltage.

The green, yellow or red LED will light depending on the battery state-of-charge (SOC). Confirm that one of these LEDs is on before going to the next step.

Close solar disconnect. If the solar input is connected while in sunlight, the charging LED indicator will light. Confirm proper connection by observing the charging LED.

Insert the load fuse, or close the breaker, and turn the

load on to confirm a proper connection. If the load does not turn on, it could be for various reasons: the ProStar is in LVD (red LED on); there is a short circuit in the load (LEDs blinking R/G – Y); there is an overload condition (LEDs blinking R/Y - G); the load is not connected, not working, or turned off. After all connections have been completed, observe the LEDs to make sure the controller is operating normally for system conditions. If the optional digital meter is used, observe that the display is scrolling with proper voltage and current values. Also, a self- test can be performed with digital meter units.

#### STEP 9: To Power Down



#### **CAUTION: Risk of Damage**

*ONLY disconnect the battery from the ProStar AFTER the solar input has been disconnected. Damage to the controller may result if the battery is removed while the ProStar is charging.*



#### **ATTENTION : Risque de dommages**

*Débranchez la batterie du ProStar UNIQUEMENT APRÈS que l'entrée solaire a été déconnectée. Le contrôleur peut être endommagé si la batterie est retirée pendant le chargement du ProStar.*

- To prevent damage, power-down must be done in the reverse order as power-up.

## 4.0

## OPERATION

### 4.1 Battery Charging Information

#### 4-Stage Charging

The ProStar has a 4-stage battery charging algorithm for rapid, efficient, and safe battery charging. Figure 4-1 below shows the sequence of stages.

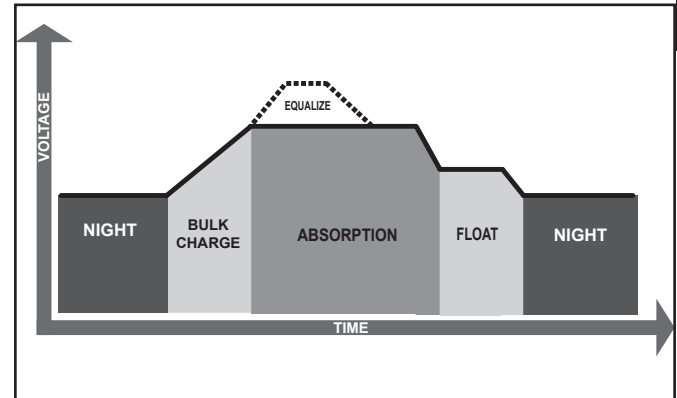

Figure 4-1. ProStar Charging Algorithm

#### Bulk Charge Stage

During Bulk charging, the battery is not at 100% state of charge and battery voltage has not yet charged to the Absorption voltage set-point. The controller will deliver 100% of available solar power to recharge the battery.

## Absorption Stage

---

When the battery has recharged to the Absorption voltage set-point, constant voltage regulation is used to maintain battery voltage at the Absorption set-point. This prevents heating and excessive battery gassing. The battery is allowed to come to full state of charge at the Absorption voltage set-point. The green SOC LED will blink once per second during Absorption charging. The battery must remain in the Absorption charging stage for a cumulative 150 - 180 minutes, depending on battery type, before transition to the Float stage will occur. However, Absorption time will be extended by thirty minutes if the battery discharges below 12.50 Volts (12V system) the previous night.

The Absorption set-point is temperature compensated through either the on-board local temperature sensor, or an optional Remote Temperature Sensor (RTS).

## Float Stage

---

After the battery is fully charged in the Absorption stage, the ProStar reduces the battery voltage to the Float voltage set-point. When the battery is fully recharged, there can be no more chemical reactions and all the charging current is turned into heat and gassing. The float stage provides a very low rate of maintenance charging while reducing the heating and gassing of a fully charged battery. The purpose of float is to protect the battery from long-term

overcharge. The green SOC LED will blink once every two (2) seconds during Float charging.

Once in Float stage, loads can continue to draw power from the battery. In the event that the system load(s) exceed the solar charge current, the controller will no longer be able to maintain the battery at the Float set-point. Should the battery voltage remain below the Float set-point for a cumulative sixty minute period, the controller will exit Float stage and return to Bulk charging.

The Float set-point is temperature compensated through either the on-board local temperature sensor, or an optional Remote Temperature Sensor (RTS).

## Equalization Stage

---



### **WARNING: Risk of Explosion**

*Equalizing vented batteries produces explosive gases. The battery bank must be properly ventilated.*

**AVERTISSEMENT : Risque d'explosion**

L'égalisation des batteries ventilées produit des gaz explosifs. Le parc de batteries doit être correctement ventilé.

**CAUTION: Equipment Damage**

Equalization increases the battery voltage to levels that may damage sensitive DC loads. Verify all system loads are rated for the temperature compensated Equalize voltage before beginning an Equalization charge.

**ATTENTION : Dommages matériels**

L'égalisation augmente la tension de la batterie à des niveaux susceptibles d'endommager les charges CC sensibles. Vérifiez que toutes les charges du système sont évaluées pour la tension d'égalisation compensée en température avant de commencer une charge d'égalisation.

**CAUTION: Equipment Damage**

Excessive over-charging and gassing too vigorously can damage the battery plates and cause shedding of active material from the plates. An equalization that is too high, or too long, can be damaging. Review the requirements for the particular battery being used in your system.

**ATTENTION : Dommages matériels**

Une surcharge excessive et un gazage trop vigoureux peuvent endommager les plaques de batterie et provoquer une perte de matière active

des plaques. Une égalisation trop élevée ou trop longue peut être dommageable. Passez en revue les conditions requises pour la batterie particulière utilisée dans votre système.

Certain battery types benefit from a periodic boost charge to stir the electrolyte, level the cell Voltages, and complete the chemical reactions. Equalization (EQ) charging raises the battery voltage above the standard absorption voltage so that the electrolyte gases. The green SOC LED will blink rapidly two (2) times per second during equalization charging.

The duration of the equalize charge is determined by the selected battery type. See table 4-1 in this section for more details. The Equalization Time is defined as time spent at the equalize set-point. If there is insufficient charge current to reach the equalization voltage, the equalization will terminate after an additional sixty minutes to avoid over-gassing or heating of the battery.

If the battery requires more time in equalization, with non-metered versions, manual EQ can be activated using the push-button (see Section 4.4) to continue for one or more additional EQ cycles. The ProStar meter, or MSView software, can also be used to program EQ timing and duration.

The Equalization set-point is temperature compensated through either the on-board local temperature sensor, or an optional Remote Temperature Sensor (RTS).

## Why Equalize?

Routine equalization cycles are often vital to the performance and life of a battery - particularly in a solar system. During battery discharge, sulfuric acid is consumed and soft lead sulfate crystals form on the plates. If the battery remains in a partially discharged condition, the soft crystals will turn into hard crystals over time. This process, called "lead sulfation", causes the crystals to become harder over time and more difficult to convert back to soft active materials. Sulfation from chronic undercharging of the battery is the leading cause of battery failures in solar systems. In addition to reducing the battery capacity, sulfate build-up is the most common cause of buckling plates and cracked grids. Deep cycle batteries are particularly susceptible to lead sulfation.

Normal charging of the battery can convert the sulfate back to the soft active material if the battery is fully recharged. However, a solar battery is seldom completely recharged, so the soft lead sulfate crystals harden over a period of time. Only a long controlled overcharge, or equalization, at a higher voltage can reverse the hardening of sulfate crystals.

## When to Equalize?

The ideal frequency of equalizations depends on the battery type (lead-calcium, lead-antimony, etc.), the depth of discharging, battery age, temperature, and other factors. One very broad guide is to equalize flooded batteries every one to three

months or every five to ten deep discharges. Some batteries, such as the L-16 group, will need more frequent equalizations.

The difference between the highest cell and lowest cell in a battery can also indicate the need for an equalization. Either the specific gravity or the cell voltage can be measured. The battery manufacturer can recommend the specific gravity or voltage values for your particular battery.

## Preparation for Equalization

First, confirm that all of the system loads are rated for the equalization voltage.

Consider that at 0°C (32°F) the Equalization voltage will reach 16.75 Volts for L-16 batteries with a temperature sensor installed.

Disconnect any loads at risk of damage due to the high input voltage.

If Hydrocaps are used, be sure to remove them before starting an equalization. Replace the Hydrocaps with standard battery cell caps. The Hydrocaps can get very hot during an equalization. After the equalization is finished, add distilled water to each cell to replace gassing losses. Confirm that the battery plates are submerged.

## Equalize a Sealed Battery?

The Battery Charging Settings table (see table 4-1 below, in this section) shows two sealed battery

settings with an Equalization cycles. These are minimal "boost" cycles to level individual cells. This is not an equalization, and will not vent gas from sealed batteries that require up to 14.4V charging (12V battery).

Many VRLA batteries, including AGM and gel, have charging requirements up to 14.4V (12V battery). Depending on the battery manufacturer's recommendation, the "boost" cycle for sealed cells can be disabled by setting the equalize setting switch to manual, if required.

### Battery Charge Settings

The ProStar provides seven (7) standard battery charging settings that are selected with the settings switches (see Table 4.1 above).

These standard charging settings are suitable for lead-acid batteries ranging from sealed (gel, AGM, maintenance-free) to Flooded and L-16 cells. In addition, an eighth charging setting provides for custom set-points using MSView™ PC software. Table 4-1 below summarizes the major parameters of the standard charging settings. The shared settings in Table 4-2 are common to all battery types.

**NOTE:** These settings are general guidelines for use at the operator's discretion. Consult the battery manufacturer for optimal battery charge settings.

### Battery Charging Set-points (@ 25°C): [multiply voltages by (2) for 24 Volt systems]

DIP Switch Settings 4-5-6	Battery Type	Absorp. Stage (volts)	Float Stage (volts)	Equalize Stage (volts)	Absorp. Time (mins)	Equalize Time (mins)	Equalize Timeout (mins)	Equalize Interval (days)
off-off-off	1 - Sealed*	14.00	13.50		150			
off-off-on	2 - Sealed*	14.15	13.50	14.40	150	60	120	28
off-on-off	3 - Sealed*	14.30	13.50	14.60	150	60	120	28
off-on-on	4 - AGM/Flooded	14.40	13.50	15.10	180	120	180	28
on-off-off	5 - Flooded	14.60	13.50	15.30	180	120	180	28
on-off-on	6 - Flooded	14.70	13.50	15.40	180	180	240	28
on-on-off	7 - L-16	15.40	13.40	16.00	180	180	240	14
on-on-on	8 - Custom	Custom	Custom	Custom	Custom	Custom	Custom	Custom

\* "Sealed" battery type includes gel and AGM batteries

Table 4-1. Charging parameters for each selectable battery type

Shared Settings	Value	Units
Absorption Extension voltage	12.50	Volts
Absorption Extension Time	Absorption Time + 30	Minutes
Float Exit Time-out	30	Minutes
Float Cancel voltage	12.10	Volts
Equalize Time-out	Equalize Time + 60	Minutes
Temperature Compensation Coefficient	- 30	Millivolts / °C / 12V

Table 4.2. Battery settings that are shared between all battery types

## Absorption Extension

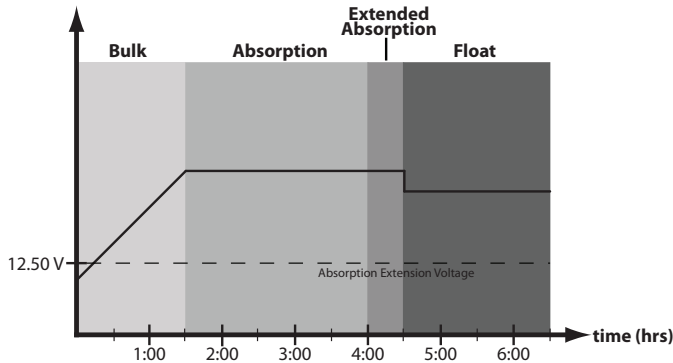

Figure 4-2. Absorption Extension Charging Profile

If battery voltage discharges below 12.50 Volts (25.00 Volts @ 24V) the previous night, Absorption charging will be extended on the next charge cycle as shown in figure 4-2 above. Thirty minutes will be added to the normal Absorption duration.

## Float Time-out

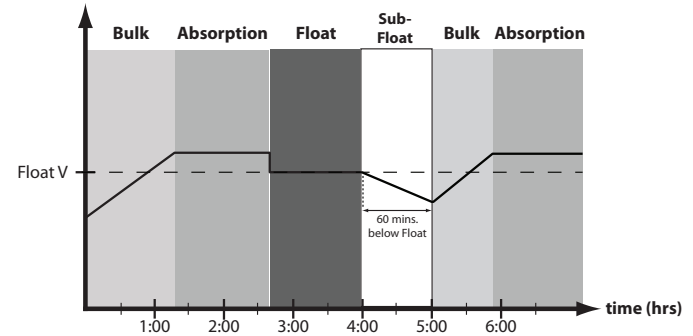

Figure 4-3. Float Exit Time-out Charging Profile

After entering Float stage, the controller will only exit Float if the battery voltage remains below Float voltage for sixty cumulative minutes. In figure 4-3, a system load turns on at 3:30 hrs when the controller is in Float stage, runs for one hour, and turns off at 4:30 hrs. The load current draw is larger than the charge current, causing battery voltage to drop below Float voltage for sixty minutes. The time-out causes the controller to return to Bulk charging, and then Absorption stage again. In this example, a load runs continuously for sixty minutes.

However, because the Float exit timer is cumulative, multiple momentary load events that pull the battery voltage below Float voltage for a combined sixty minute duration will also force an exit from Float stage.

### Float Cancel voltage

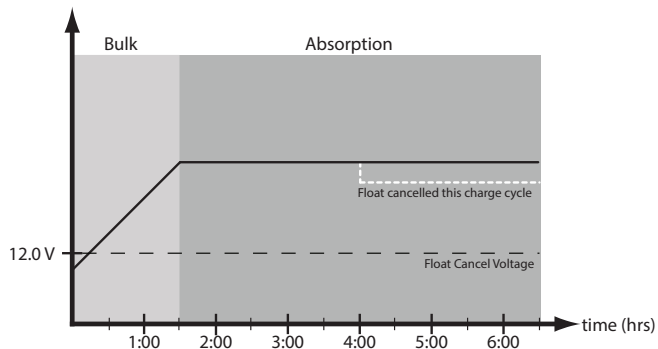

Figure 4.4. Float Cancellation Charging Profile

If the battery bank discharges below 12.10 Volts (24.20 Volts @ 24V) the previous night, Float charging stage will be cancelled for the next charge cycle. Figure 4-4 above, illustrates this concept. At 0:00 hrs (dawn), battery voltage is below the Float Cancel threshold voltage. The diagram shows where Float stage would have occurred if Float was not cancelled.

### Equalize Time-out

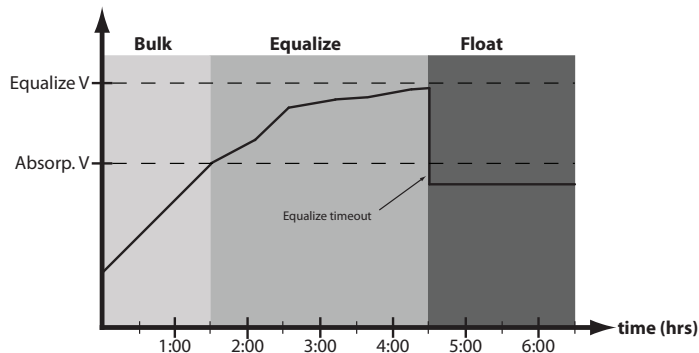

Figure 4.5. Equalize time-out charging profile

The charging profile in figure 4-5 above, shows an Equalize Time-out event. The time-out timer begins as soon as battery voltage exceeds the Absorption voltage set-point. If there is insufficient charging current or system loads are too large, the battery voltage may not reach the Equalize set-point. To avoid battery damage, The Equalize Time-out safety feature prevents high battery voltage for extended periods of time.



## 4.2 Load Control Information

---

The primary purpose of the load control function is to disconnect system loads when the battery has discharged to a low state of charge, and reconnect system loads when the battery is sufficiently recharged. The total current draw of all loads must not exceed the ProStar 15 or 30 Amp maximum load rating.

### Current Compensation:

All LVD and LVR set-points are current compensated. Under load, the battery voltage will sag in proportion to the current draw of the load. A short-term large load could cause a premature LVD without the current compensation feature. LVD and LVR set-points are adjusted lower per the following table:

System voltage	Current Compensation
12 Volt	-20 mV per Amp of load
24 Volt	-40 mV per Amp of load

Table 4-3. LVD and LVR Current Compensation Values

### LVD Warning:

As the battery discharges the Battery Status LEDs will transition from green to yellow and then from yellow to flashing red. The flashing red indication is a warning that a low voltage disconnect event will occur soon.

The amount of time between a green SOC indication and load disconnect will depend on many factors including:

- rate of discharge - based on amount of load current
- capacity of the battery
- health of the battery
- LVD set-point

If the battery discharges to the LVD set-point the load will disconnect and a solid red Battery Status LED indication will be displayed.

### General Load Control Notes:

Do not wire multiple ProStar load outputs together in parallel to power DC loads with a current draw greater than 15 or 30A, depending on the ProStar model. Equal current sharing cannot be assured and an over-load condition will likely occur on one or more controllers.

Exercise caution when connecting loads with specific polarity to a live load circuit. A reverse polarity connection may damage the load. Always double check load connections before applying power.



Condition	Indication
Absorption	<b>G</b> flash - every sec
Float	<b>G</b> flash - every 2 secs
Start Equalization (push-button)	[ <b>G / Y / R</b> ] x2 - <b>G - G</b>
Stop Equalization (push-button)	[ <b>G / Y / R</b> ] x2 - <b>R - R</b>
Equalize	<b>G</b> flash - 2 / sec
SOC > 13.5V	<b>G</b> solid
13.5V > SOC > 13.0V	<b>G / Y</b> solid
13.0V > SOC > 12.5V	<b>Y</b> solid
SOC < 12.5V	<b>Y / R</b> solid
Low voltage disconnect warning	<b>R</b> flash - every sec
Low voltage disconnect	<b>R</b> solid

Table 4.5. Battery SOC LED Indications

#### 4.4 Push-Button Use in Non-Metered Versions

The non-metered version of the ProStar features a push-button that operates as follows depending on the DIP Switch 1 setting:

Normal Mode (DIP 1 OFF), (operation effective with firmware v6.0 and higher)

A quick press of the push-button will toggle the load voltage between ON and OFF.

- The load will not toggle ON-OFF when the unit is in LVD.
- Regardless of the DIP 7 setting, press and hold the push-button for five seconds to initiate or stop an Equalization (EQ).

#### Lighting Control Mode (DIP 1 ON)

A quick press will then conduct a ten minute lighting test. A lighting test is used to verify correct wiring in the load circuit, and/or verify that the lighting components are operational. A lighting test will override LVD for ten minutes - the override duration is not programmable.

- Press and hold the push-button for five seconds to initiate or stop an EQ.

#### Reset ProStar to Factory Settings

To restore factory settings: Disconnect PV; disconnect battery power; press and hold down the push-button; re-start the ProStar by connecting the battery; keep the push-button depressed for 3-5 secs, until the battery LEDs start to cycle R-Y-G.

A Custom Settings Edit fault will occur - see Section 5 for details. The unit will then need to be re-powered to resume normal operation.

### 4.5 Custom Settings

#### 4.5.1 Programming with the Meter Display

The ProStar is available in metered and non-metered versions. The metered model allows:

- custom programming, including lighting programs, directly from the unit.
- extensive settings adjustment and information as

shown partially in Figure 4-6 below.

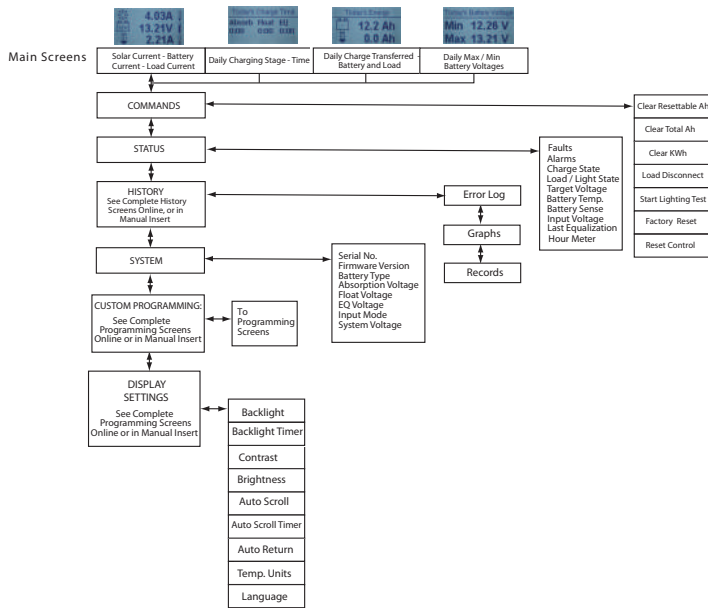

Figure 4-6. Simplified Meter Map. For metered models, see the included complete meter map insert, also available in the ProStar support documents at:

<http://www.morningstarcorp.com>

## 4.5.2 Programming in MSView

Beyond the preset DIP switch options, the ProStar’s charging profile and all other settings are customizable using MSView PC software available at:

<http://www.morningstarcorp.com/msview>

With a connection to a PC, and to the RJ-11 port of the ProStar, the MSView ProStar Set-up Wizard is capable of editing all charging and lighting parameters, for upload to the controller. The Set-up Wizard, and topics within the Help tab describe programming procedures in detail.

All aspects of connection and programming are covered in the Product Connectivity Manual:

[www.morningstarcorp.com](http://www.morningstarcorp.com)

## 4.5.3 Meter Display Operation

### 4.5.3.1 Directional Key Use and Operation / Navigating the Meter Map

The ProStar’s meter map consists of two main axes: The horizontal top level daily monitoring screens, and the vertical Main Menu stacked screens. The four lighted triangular directional control keys allow movement to reach any desired point on the meter map. A lit key indicates a valid direction in the map. The current location is indicated on the display with a column heading, and a bold descriptor.

### 4.5.3.2 Adjusting the Meter Display

The display setting options, as seen in Figure 4-6, are adjustable by using the directional keys to locate and edit a desired setting or variable.

### 4.5.4 Using the Meter Display to Program Charging Set-points, Load Control, Communications, and Advanced Settings

.....

Refer to the complete meter map insert for metered ProStars. From a top level monitoring screens, scroll down to the Main Menu - "Custom Programming" - screen. Select the desired category, and edit the variable or settings as instructed in the meter display. Note that charging set-points should be entered as if for a 12V system - DIP switches 2 and 3 settings prompt the controller to multiply if necessary. See Section 3.2 for configuration details.

The Load Control category includes Normal (load disconnect) and Lighting programming. The Advanced Settings category includes more optional charging, and load control settings.

### 4.5.5 Lighting Control - Programming Overview

.....

The ProStar display has extensive lighting load programmability. With DIP switch 1 ON (up), a dusk-dawn lighting program is enabled, if lighting timing hasn't been programmed in MSView or using the meter; with DIP 1, 4, 5, 6 ON, and the unit programmed, custom timing will be in effect. With DIP 1 OFF (down), all lighting control functions are disabled.

Using either MSView or the meter display, four channels are available for setting timers that can work separately, or in combination. See Section 4.5.6 - Lighting Programming Using the Meter Display - for more details.

### 4.5.6 Lighting Programming Using the Meter Display

.....

Lighting programming capabilities are accessible with the meter via Custom Programming->Load Control ->Lighting. Lighting settings editing is done via on-screen instructions.

- The Summary provides a graphical representation of the complete lighting configuration.
- LVD / LVR can be specified for use when a lighting program is in operation.
- Sunrise and Sunset Threshold settings allow the adjustment of percentages of the maximum seen solar array voltage for triggering day and night events.
- There are four channels, each having two timers, which can be used independently, or in combination.
- Events and actions are used as references and controls. An event is one of eight points in a day, e.g., sunrise or midnight. Each event can be edited to specify a time offset to trigger an action, which can be, "Do Nothing", "Lights On", or "Lights Off".
- The combination setting of each channel will specify whether the actions and events of each

timer will function: Not at all (no combination); when both timers' settings match (AND); for either timer's settings (OR).

#### 4.5.7 Low Temperature Foldback

The ProStar has a Low Temperature Foldback option which can be used to protect lithium batteries from being charged in cold conditions. Custom settings defining the bounds of charge current reduction due to low battery temperature can be programmed in MSView, or with the Advanced Custom Settings options with the display interface. Advanced Custom Settings options are available with ProStar built-in meter models.

The High Limit defines the lowest temperature at which the controller will deliver 100% of the controller's rated output charging current. The Low Limit defines the temperature at which the controller will stop providing battery charging current. The charge current is tapered linearly from the High Limit to the Low Limit.

**NOTE:** Local meter display setup required for Low Limit < 1° Celsius.

## 4.6 Inspection and Maintenance

Table 4-6 below, lists the recommended maintenance schedule to keep your ProStar performing optimally.

Schedule	Maintenance Items
2 weeks after installation	Re-tighten power terminal connections to specified torque values.
3 months after installation	Re-tighten power terminal connections to specified torque values.
Monthly, or After Each Equalization	Inspect the battery bank. Look for cracked or bulging cases, and corroded terminals.  For wet cell (flooded type) batteries, make sure the water level is correct. Wet cell water levels should be checked monthly or according to the manufacturer's recommendations.

Table 4-6. Maintenance Schedule (Cont.)

Schedule	Maintenance Items
Annually	<p>Clean the heatsink fins with a clean, dry rag.</p> <p>Inspect all wiring for damage or fraying.</p> <p>Inspect for nesting insects.</p> <p>Re-tighten all wiring terminal connections to specified torque values.</p> <p>Inspect the system earth grounding for all components. Verify all grounding conductors are appropriately secured to earth ground.</p>

Table 4-6. Maintenance Schedule (End)

## 5.0 TROUBLESHOOTING

### 5.1 Alarms

#### High Temperature Current Limit

The ProStar will limit the solar input current if the heatsink temperature exceeds safe limits. Solar charge current will be de-rated (to 0 Amps if needed) to reduce the heatsink temperature. The ProStar is designed to operate at full rated current at the maximum rated ambient temperature. This alarm indicates that there is insufficient airflow and that the heatsink temperature is approaching unsafe limits. If the controller frequently reports this alarm condition, corrective action must be taken to provide better air flow or to relocate the controller to a cooler spot.

#### RTS Open

The Remote Temperature Sensor is not connected to the controller. Use of the RTS is recommended for proper battery charging.

#### Heatsink Temperature Sensor Open or Shorted

The heatsink temperature sensor is damaged. Return the controller to an authorized Morningstar dealer for service.

#### Battery Sense Out of Range / Disconnected (only alarm with LED indications)

Battery status LEDs: R/Y - G/Y sequencing. A battery sense wire is disconnected. Inspect the battery sense connections. This alarm is set when the voltage at the

battery sense terminals differs by more than five volts from the voltage at the battery terminals.

### **Uncalibrated**

The controller was not factory calibrated. Return the controller to an authorized Morningstar dealer for service.

## **5.2 LED Fault Indications**

---

### **Solar Over-current**

Error status LED: Flashing red. Battery status LEDs: R/Y-G sequencing. When the ProStar's rated input current is exceeded, the unit will interrupt array current until it falls below the controller's maximum capacity.

If solar input exceeds 100% of the ProStar's current rating, the average current will be reduced to the ProStar's maximum rating. The controller is capable of managing up to 110% of the rated solar input. When 110% of rated current is exceeded, solar input will be disconnected, and a fault will be indicated. The input FET switches will remain open for ten (10) seconds. Then the switches are closed again and charging can resume. These cycles can continue without limit.

### **Load Over-current**

Error Status LED: Flashing red. Battery status LEDs: R/Y-G sequencing. If the load current exceeds the maximum load current rating, the ProStar will disconnect the load. The greater the overload, the

faster the load will be disconnected. A small overload could take a few minutes to disconnect. The ProStar will attempt to reconnect the load two (2) times. Each attempt is approximately ten (10) seconds apart. If the overload remains after two (2) attempts, the load will remain disconnected until power is removed and re-applied.

### **Solar Short Circuit**

Charging Status LED: OFF. Solar input power wires are short-circuited. Charging automatically resumes when the short is cleared.

### **Battery Reverse Polarity**

No LED indication, the unit is not powered. No damage to the controller will result. Correct the mis-wire to resume normal operation.

### **Load Short Circuit**

Error status LED: Flashing red. Battery status LEDs: R/G-Y sequencing. Fully protected against load wiring short-circuits. After two (2) automatic load reconnect attempts (10 seconds between each attempt) the ProStar will wait, and then automatically reconnect the load, once the short is cleared.

### **High Solar Voltage**

Charging Status LED: R flashing. No battery status indications. If the solar input open-circuit voltage (Voc) exceeds the 60 Volt maximum rating, the array will remain disconnected until the Voc falls safely below the maximum voltage.



### **Remote Temperature Sensor (RTS)**

Error status LED: Flashing red. Battery status LEDs: R/Y - G/Y sequencing. A bad RTS connection or a severed RTS wire has disconnected the temperature sensor during charging. Charging automatically resumes when the problem is fixed. To resume operation without an RTS, disconnect all power to the ProStar and then reconnect. If the controller is re-started with the failure still present, the controller may not detect that the RTS is connected, and the LEDs will not indicate a fault. A metered model, an RM-1 meter, or MSView PC software can be used to determine if the RTS is working properly.

### **Solar-Battery High Voltage Disconnect (HVD)**

Error status LED: Flashing red. Battery status LEDs: R-G sequencing. This fault is set when battery voltage is above normal operating limits. The controller will disconnect the solar input and set a Solar High Voltage Disconnect Fault. This fault is commonly caused by other charging sources in the system, charging the battery above the ProStar regulation voltage. Recovery occurs at HVD re-connect threshold, and the fault will clear automatically.

### **Load High Voltage disconnect (HVD) - disabled by default**

Error status LED: None. Battery status LEDs: R-G sequencing. This fault is set when battery voltage is above normal operating limits. The controller will disconnect the load output and set a Load High Voltage Disconnect fault. This fault is designed to protect sensitive loads from excessive voltage.

Recovery occurs at HVD re-connect threshold, if programmed, and the fault will clear automatically.

### **High Heatsink Temperature**

Error status LED: Flashing red. Battery status LEDs: R-Y sequencing. The heatsink temperature has exceeded safe limits. Charging will cease, and the load is disconnected. The load will automatically be reconnected, and charging will resume when the heatsink cools to a safe temperature.

### **Settings (DIP) Switch Changed**

Error status LED: Flashing red. Battery status LEDs: R-Y-G sequencing. If a settings switch is changed while there is power to the controller, the LEDs will begin sequencing and the solar input will be disconnected. The controller must be re-started to clear the fault and begin operation with the new settings.

### **Custom Settings Edit**

Error status LED: Flashing red. Battery status LEDs: R-Y-G sequencing. A value has been modified in custom settings memory. The controller will stop charging and indicate a fault condition. After all settings have been modified, the controller must be reset by removing and then restoring power to the controller. The new programmed settings will be used after the power reset.

## Firmware Update Failure

The firmware update was not successfully programmed. The controller will not indicate the full power-up LED sequence of G-Y-R when power to the controller is reset. Instead, the controller will display green, and then stop on yellow. The yellow LED will continue to be lit and the controller will not complete start up or begin charging. Re-try the firmware update. The firmware must be successfully loaded before the controller will start up.

## Internal Power Supply Out-of-Range

Error status LED: Solid red. Battery status LEDs: R-Y-G sequencing. The processor supply voltage is not correct. Contact your Morningstar dealer for service.

## SOLID CHARGING STATUS LED with SELF-TEST (R-Y-G) SOC FAULTS

Verify that nothing has been mis-wired. If not, the error is likely critical. Contact an authorized Morningstar dealer for support.

Fault	Charging Status LED	Battery SOC LEDs
PV FET Short	Solid red	R-Y-G sequencing
Load FET Short	Solid red	R-Y-G sequencing
Load FET Open	Solid red	R-Y-G sequencing

Damaged local temperature sensor	Solid red (only if RTS is invalid)	R-Y-G sequencing
Damaged heatsink temperature sensor	Solid red	R-Y-G sequencing
Software	Solid red	R-Y-G sequencing
Internal power supply out of range	Solid red	R-Y-G sequencing

## RE-SETTABLE SELF-TEST (R-Y-G) SOC FAULTS

Fault	-	Battery SOC LEDs
Custom Settings Edit	-	R-Y-G sequencing
DIP Switch Change	-	R-Y-G sequencing

## 5.3 Battery Charging and Performance Issues

### Problem:

No LED indications, controller does not appear to be powered.

### Solution:

With a multi-meter, check the voltage at the battery terminals on the ProStar. Battery voltage must be 10 vdc or greater. If the voltage on the battery terminals of the controller is between 10 and 35 vdc, and no LEDs are lit, contact your authorized Morningstar dealer for service. If no voltage is measured, check wiring connections, fuses, and breakers.

**Problem:**

The ProStar is not charging the battery.

**Solution:**

Check the three (3) battery SOC LEDs. If they are flashing in a sequence, see Section 5.2 - LED Fault Indications - of this manual to determine the cause. A metered model, an RM-1 meter, or MSView PC software will display active faults and alarms.

If the LED indications are normal, check the fuses, breakers, and wiring connections in the power source wiring. With a multi-meter, check the array voltage directly at the ProStar solar input terminals. Input voltage must be greater than battery voltage before charging will begin.

**Problem:**

Controller makes buzzing and humming noises.

**Solution:**

No action is required. This is expected due to magnetic resonance and circuit switching.

**If troubleshooting does not correct the problem, please refer to Morningstar's Warranty Claim Procedure in Section 6.**

## 6.0 WARRANTY AND POLICIES

### WARRANTY

#### LIMITED WARRANTY - Morningstar Solar Controllers and Inverters

---

Integrated Series products, SureSine Family (Gen 2) inverters and other Morningstar *Professional Series*<sup>TM</sup> products, except the SureSine<sup>TM</sup>-300 Classic (Gen 1) inverter, are warrantied to be free from defects in materials and workmanship for a period of FIVE (5) years from the date of shipment to the original end user. Warranty on replaced units, or field-replaced components, will be limited only to the duration of the original product coverage.

Morningstar *Essentials Series*<sup>TM</sup> products, and SureSine<sup>TM</sup>-300 Classic (Gen 1) inverter, are warrantied to be free from defects in materials and workmanship for a period of TWO (2) years from the date of shipment to the original end user. Warranty on replaced units, or field-replaced components, will be limited only to the duration of the original product coverage.

Morningstar will, at its option, repair or replace any such defective units.

#### CLAIM PROCEDURE:

Before requesting warranty service, check the operator's manual, including any troubleshooting section, to verify product failure. To begin the warranty replacement process, contact your authorized

Morningstar distributor or dealer for assistance with troubleshooting and, if necessary, obtaining an RMA number.

**An RMA number must be issued by Morningstar prior to return of any unit(s) under this warranty. Required RMA information:**

- (A) purchase location, date, business or company name
- (B) full model and serial numbers (SN is 8-digits on unit bar label)
- (C) failure behavior, including LED indications
- (D) array configuration, panel Pmax, Voc, Vmp, Isc, and nominal battery voltage - these specifications are needed to receive assistance.
- (E) multi-meter available (for field troubleshooting)

After the dealer is contacted, and is not able to assist with warranty claim, contact Morningstar Technical support at [support@morningstarcorp.com](mailto:support@morningstarcorp.com). Please provide proof of date and place of purchase, and all details listed in preceding paragraph.

**WARRANTY EXCLUSIONS AND LIMITATIONS:**

This warranty does not apply under the following conditions:

- damage by accident, negligence, abuse or improper use
- PV or load currents exceeding the ratings of the product

- unauthorized product modification or attempted repair
- damage occurring during shipment
- damage resulting from acts of nature such as lightning, weather extremes, or infestation

THE WARRANTY AND REMEDIES SET FORTH ABOVE ARE EXCLUSIVE AND IN LIEU OF ALL OTHERS, EXPRESS OR IMPLIED. MORNINGSTAR SPECIFICALLY DISCLAIMS ANY AND ALL IMPLIED WARRANTIES, INCLUDING, WITHOUT LIMITATION, WARRANTIES OF MERCHANTABILITY AND FITNESS FOR A PARTICULAR PURPOSE. No Morningstar distributor, agent or employee is authorized to make any modification or extension to this warranty.

MORNINGSTAR IS NOT RESPONSIBLE FOR INCIDENTAL OR CONSEQUENTIAL DAMAGES OF ANY KIND, INCLUDING BUT NOT LIMITED TO LOST PROFITS, DOWN-TIME, GOODWILL OR DAMAGE TO EQUIPMENT OR PROPERTY.

Morningstar Corporation  
8 Pheasant Run, Newtown, PA 18940 USA  
(215) 321-4457

[www.morningstarcorp.com](http://www.morningstarcorp.com)  
[support@morningstarcorp.com](mailto:support@morningstarcorp.com)

R20-4/23

## 7.0 TECHNICAL SPECIFICATIONS

PS-15 PS-30  
PS-15M PS-30M

### Electrical:

Nominal Battery voltage	12 or 24 Volts
Battery voltage Range	10-35 Volts
Voltage accuracy	0.1% +/- 50mV (all)
Max. Battery Current	15 Amps 30 Amps
Max. PV open-circuit voltage	60 Volts <sup>1</sup>
Load Current Rating	15 Amps 30 Amps
Self Consumption	<22mA (no meter) <40mA (meter)
LED Indications	(1) status, (3) battery SOC
Transient Surge Protection	1500 watts (solar, battery, load)

### Mechanical:

Dimensions:	6.01(W) x 4.14(L) x 2.17(D) in. 153(W) x 105(L) x 55(D) mm
Weight:	13.8 oz. (no meter) 15.1 oz. (with meter)
Wire Size Range:	
Power Terminals	2.5 - 13.3 mm <sup>2</sup> / #14 - 6
AWG	
Maximum Torque	35 in-lb (4 N-m)
Battery/Temp. Sense	0.25 - 1.0 mm <sup>2</sup> / #24 - 16 AWG
Enclosure	IP20, Type 1

### Battery Charging:

4-Stage Charging:	Bulk, Absorption, Float, Equalize
Temperature compensation	
Coefficient:	-30mV / °C / 12 Volt
Temperature compensated set-points:	Absorption, Float, Equalize, HVD

<sup>1</sup> Hardware specification - not for design purposes

**Battery Charging Set-points (@ 25°C):**  
[multiply voltages by (2) for 24 Volt systems]

DIP Switch Settings 4-5-6	Battery Type	Absorp. Stage (volts)	Float Stage (volts)	Equalize Stage (volts)	Absorp. Time (mins)	Equalize Time (mins)	Equalize Timeout (mins)	Equalize Interval (days)
off-off-off	1 - Sealed*	14.00	13.50		150			
off-off-on	2 - Sealed*	14.15	13.50	14.40	150	60	120	28
off-on-off	3 - Sealed*	14.30	13.50	14.60	150	60	120	28
off-on-on	4 - AGM/Flooded	14.40	13.50	15.10	180	120	180	28
on-off-off	5 - Flooded	14.60	13.50	15.30	180	120	180	28
on-off-on	6 - Flooded	14.70	13.50	15.40	180	180	240	28
on-on-off	7 - L-16	15.40	13.40	16.00	180	180	240	14
on-on-on	8 - Custom	Custom	Custom	Custom	Custom	Custom	Custom	Custom

\* "Sealed" battery type includes gel and AGM batteries

### Current Compensation:

12 Volt systems	-15 mV/A
24 Volt systems	-30 mV/A
Compensated set-points	LVD, LVR

### Load and Solar Control:

[multiply voltages by (2) for 24 Volt systems]

Default values (customizable)

LVD <sup>1</sup>	11.5V
LVR <sup>1</sup>	12.6V
Instant LVD	10.0V
HVD - solar	Highest set-point in preset charging profile [+ 0.5V (@ 25°C)]
HVD - load <sup>1</sup>	Disabled
HVDR - solar	13.8V (@ 25°C)
HVDR - load <sup>1</sup>	Disabled
LVD Warning	10 mins

<sup>1</sup> Applies to units with Firmware v18 and higher

LVD Override - Lighting Test	10 mins
Maximum # LVD overrides (not customizable)	No limit unless V <sub>batt</sub> < Instant LVD

#### Lighting Control (DIP 1 ON):

Lighting Timer Setting	Dusk-Dawn (default)
Lighting Test Timer	10 mins

#### Data & Communications:

Communication Port	MeterBus (RJ-11)
Comm. Protocols	Morningstar MeterBus; MODBUS

Data-logging 6-8 months, daily records

PC Software MSView

#### Digital Meter:

Resolution	128 x 64 pixels
Viewing Area	50 mm x 25 mm
Display Color	blue on white
Backlight	LED
Operating Temperature	-20°C to +70°C
Storage Temperature	-30°C to +80°C

#### Environmental:

Maximum Operating Altitude	2000 meters
Ambient Temperature Range:	
T5 Certified	-40°C to +60°C
Storage Temperature	-40°C to +80°C
Humidity	100% n.c.
Tropicalization	Conformally coated PCBs; Marine-rated terminals

***For hazardous location-IECEX/ATEX applications, see the addendum - part no. MS-003245-EN - to this manual.***

## **Protections**

Power-up against any active faults

Reverse Polarity - battery and array

Solar Short-circuit

Solar Over-current

High Solar Voltage Disconnect

High Heatsink Temperature - Current de-rating

High Heatsink Temperature - Load disconnect

Load Short-circuit

Load Over-current

Heatsink Temperature Limit

RTS Terminals

Battery Sense Terminals

PWM Current De-rating

## APPENDIX A - DERATING

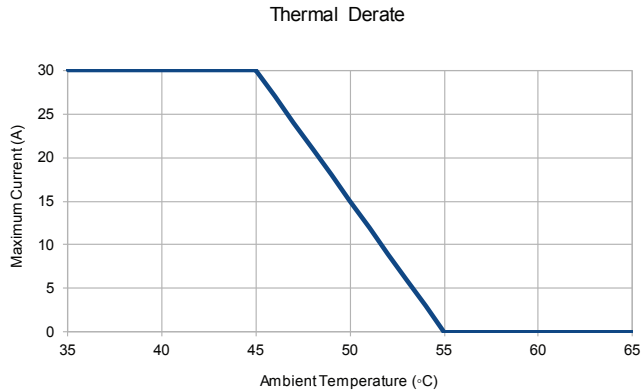

Figure A-1. Maximum Current vs. Ambient Temperature

## APPENDIX B - Voltage Drop Tables for Wire Sizing

Good system design generally requires large conductor wires that limit voltage drop losses to 2% or less. The tables below provide wire sizing for a maximum of 2% voltage drop. Longer distance wire runs may require significantly larger wire sizes to reduce the voltage drop to an acceptable level.

### 2% Voltage Drop Chart for 75°C or 90°C Stranded Copper Wire (Feet), 12 Volt System /

Maximum 1-way Distance (feet), 12 Volt System - multiply values by (2) for 24 Volt and by (4) for 48V, system. NOTE: Distances are estimates only and can vary based on temperature, type of wire or other factors.

Wire Size (AWG)	30A	25A	20A	15A	10A	8A	5A
2*	24.6	29.5	36.9	49	61	92.0	
3*	19.5	23.3	29.2	38.9	49	73.0	
4*	15.5	18.6	23.2	31.0	38.7	58	93.0
6	9.7	11.6	14.6	19.4	24.3	36.4	58.0
8	6.1	7.4	9.2	12.3	15.3	23.0	36.8
10	3.8	4.6	5.8	7.7	9.6	14.4	23.1
12		2.9	3.6	4.8	6.0	9.0	14.4
14			2.3	3.0	3.8	5.7	9.1

\* Wire sizes larger than #6 AWG must be terminated at a splicer block located external to the ProStar. Use #6 AWG or smaller wire to connect the ProStar to the splicer block.

Table B-1. Maximum one-way circuit length for 12 Volt systems, stranded copper (Feet) , 2% voltage drop

## 2% Voltage Drop Chart for 75°C or 90°C Stranded Copper Wire (meters), 12 Volt System /

Maximum 1-way Distance (meters), 12 Volt system - multiply values by (2) for 24 Volt system and by (4) for 48V system. NOTE: Distances are estimates only and can vary based on temperature, type of wire or other factors.

Wire Size (mm <sup>2</sup> )	30A	25A	20A	15A	10A	8A	5A
35*	7.5	9.0	11.3	15.0	22.6	28.2	45.1
25*	5.4	6.5	8.1	10.8	16.3	20.3	32.5
16	3.4	4.1	5.2	6.9	10.3	12.9	20.6
10	2.2	2.6	3.2	4.3	6.5	8.1	12.9
6	1.3	1.5	1.9	2.6	3.8	4.8	7.7
4	0.9	1.0	1.3	1.7	2.6	3.2	5.1
2.5			0.8	1.1	1.6	2.0	3.2

\* Wire sizes larger than 13.3 mm<sup>2</sup> must be terminated at a splicer block located external to the ProStar. Use 13.3 mm<sup>2</sup> or smaller wire to connect the ProStar to the splicer block.

Table B-2. Maximum one-way circuit length for 12 Volt systems, stranded copper (Meters) , 2% voltage drop.

**FOR CURRENT DETAILED CERTIFICATION LISTINGS, REFER TO:**

<https://www.morningstarcorp.com/support/library>

**Choose the ProStar-PWM product, and under, "Type", choose, "Declaration of Conformity" (DOC).**

ProStar™ and MeterBus™ are trademarks of Morningstar Corporation

MODBUS™ and MODBUS TCP/IP™ are trademarks of Modbus IDA.

©2024 Morningstar Corporation. All rights reserved.



# PROSTAR GEN 3 ADDENDUM TO OPERATOR'S MANUAL

Low Voltage Directive:  
IEC/EN 62109-1

## Certifications



UL1741 INVERTERS, CONVERTERS, AND CONTROLLERS AND INTERCONNECTION SYSTEM EQUIPMENT FOR USE WITH DISTRIBUTED ENERGY SOURCES, SECOND EDITION, REVISION THROUGH AND INCLUDING SEP 07, 2016

CSA C22.2#107.1-01 POWER CONVERSION EQUIPMENT

UL121201/CSA C22.2 #213 Non-incendive Electrical Equipment for Use in Class I, Division 2 Hazardous (Classified) Locations, Groups A,B,C,D, Temperature Group: T5 (see product manual environmental specifications)

EMC Directives

- Immunity: EN 61000-6-2
- Emissions: EN 61000-6-4  
CISPR 55022

## Hazardous Locations for IECEx/ATEX Applications

IECEX ETL 20.0068X  
ITS20ATEX25936X

IECEX: Ex ec ic IIC T5 Gc  
ATEX:  II 3G Ex ec ic IIC T5 Gc  
-40°C ≤ Tamb ≤ +60°C

Prostar Gen 3 must be verified with di-electric strength test specified by the relevant industrial standard.

The equipment must be placed inside an Ex-rated IP 54 enclosure in accordance with IEC 60079 series. A tool is required in order to access the equipment inside the enclosure.

Morningstar Corporation

8 Pheasant Run, Newtown, PA 18940 USA

10611 Iron Bridge Road, Ste. L, Jessup, MD 20794 USA

MS-003245-EN-5